

Telenetics®

Model 2321A Series Millimeter Wave Simplex Video Surveillance Radio Link



Installation and Operation Manual

Revision 060130

Telenetics, Inc.
4111 Citrus Avenue, Suite # 5
Rocklin, California 95677

Telephone (916) 624-7313
FAX (916) 624-5943
microwave@telenetics.com

Telenetics Microwave Group
2321S Millimeter wave Simplex Video Radio Link
Rev 060131

TABLE OF CONTENTS

- I. Technical Description**
- II. Unpacking and Inspection**
- III. Path Requirements**
- IV. Specifications**
- V. Preliminary Installation Considerations**
- VI. Installation Instructions**
- VII. Installation Drawings**
- VIII. Limited Warranty**
- IX. Glossary**

SECTION I TECHNICAL DESCRIPTION

The 2321A Radio Link provides a simplex video and one or (as an option) two full duplex data microwave channels for point to point wireless video communications. The radio link (comprising two radio terminals) consists of Two (2) Outdoor 2321A RF Head Units and Two (2) corresponding Indoor Control Units.

The 2321A RF Head includes a microwave antenna, transmitter/receiver, baseband signal modulator, and an IF down-converter to allow simultaneous simplex video and single, or optional dual, duplex data channel operation. One data channel can be utilized to provide pan/tilt/zoom camera control. The Link is powered by 93-265 VAC or optional 24 VDC or 48 VDC provided at the Indoor Control Unit. The DC supplies have "floating" inputs which allows either + or - input voltages.

Eight (8) (customer furnished) cables with mating connectors are required for installation and operation of the radio link. Two (2) are required at each end of the link between the Indoor Control Unit and the user video equipment and data network and Two (2) are required at each end of the link between the Outdoor RF Head and the Indoor Control Unit. The RG-59/U coax cable carries the TX or RX video signals between the Control Units and the customer furnished camera and monitor units. The 6 wire cable (two shielded twisted pair with the two shields) carries the RS422 control data information between the Control Units and the data network. The 5-Wire Power cable carries DC Power from the power supply in the Indoor Control Unit to the Outdoor RF Head. The 50 Ohm coaxial cable (Belden 9913 or equivalent) carries the RF signals and diagnostic information between the Outdoor RF Heads and the Indoor Control Units.

A pair of 2321A RF Heads (one video TX, and one video RX) is mounted to a pair of poles, one at each end of the communication link. The corresponding pair of 2321A Control Units are mounted in an indoor enclosure at street level. The RF Head and its Control Unit can be separated by up to 1,000 feet. A voltmeter is used to monitor the AGC voltage at each RF head during antenna alignment. The RF head mounting is adjusted to provide the maximum received signal (AGC voltage) at each end of the link. After the link is aligned, video and control data can be transmitted through the link.

**SECTION I
TECHNICAL DESCRIPTION
(continued)**

System Interface to Radio:

Video Interface: The radio link connects directly to the video camera and monitor equipment via RG-59/U (75 Ohms) coax cables terminated at the BNC female bulkhead connectors mounted on the back of the Indoor Control Units.

RS422 Interface: The radio link connects directly to the data (1 or 2 channels) equipment modem via a 6 wire (2 shielded twisted pair and the two shields) cable terminated at the DB9 connectors mounted on the back of the Indoor Control Unit, wired as follows: *There would be another DB9 for the optional second RS422 channel.*

Function	Pin
RS422 TX + In (signal into radio)	2
RS422 TX - In (signal into radio)	3
RS422 RX - Out (signal out of radio)	7
RS422 RX + Out (signal out of radio)	8
Ground (shields of the 2 twisted pair)	5,9

Do not attach wires to pins 1, 4, or 6.

Power: The radio link requires 96-265 VAC via attached 6 foot long power cord at the Indoor Control Unit. As options, 24 VDC or 48 VDC supplies are available.

Each Control Unit provides the following diagnostic indicators:

Power On	Green LED
Data 1 (Present)	Green LED
Link Status	Green LED
Data 2 (Present)	Green LED
FSE (Frequency Select Error)	Red LED
RX Alarm	Red LED
AGC Alarm	Red LED
TX Alarm	Red LED
AGC Voltage	Meter (0-10 Volts)

Indicator Description

Power On	Green LED, Illuminated whenever the Interface unit is powered on
Data 1	Green LED, Illuminated when RS422 data is present at the CH 1 Data input pin
Link Status	Green LED, Illuminated when the RF Head to Interface Unit telemetry is OK. The LED will extinguish momentarily when ever a frequency or LBO switch position is changed. It will go out if the telemetry signal is corrupted or missing.
Data 2	Green LED, Illuminated when RS422 data is present at the CH 2 Data input pin
FSE	Red LED, Illuminated when ever the frequency switch setting is in an un supported configuration
RX Alarm	Red LED, Illuminated when an RX alarm error occurs. An RX alarm error occurs when either the current to the RX microwave assembly is out of tolerance or the receive synthesizer PLL is unlocked.
AGC Alarm	Red LED, Illuminated when the receive signal strength drops below -75dBm.
TX Alarm	Red LED, Illuminated when a TX alarm error occurs. An TX alarm error occurs when either the current to the TX microwave assembly is out of tolerance or the transmitter synthesizer PLL is unlocked.
AGC Voltage Meter	Provide relative indication of field strength. The higher the meter indication the higher the AGC, and the higher the receive signal strength. Nominal AGC readings are between 4 to 9 V. This will vary to some degree form unit to unit.

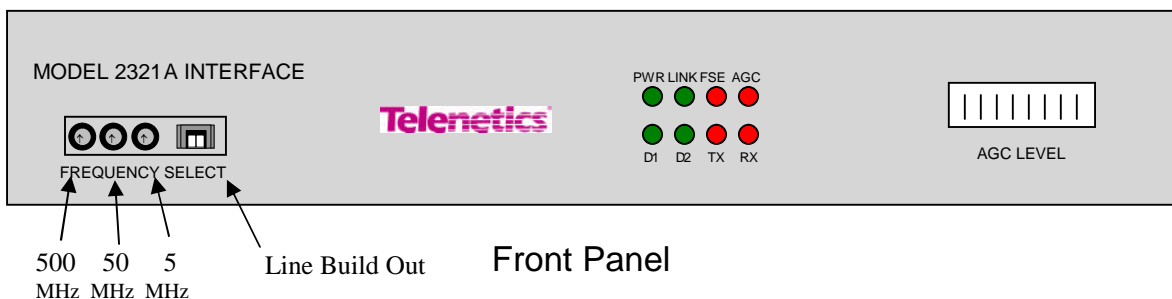

SECTION II UNPACKING AND INSPECTION

Your Telenetics Microwave Communications Millimeter Wave Link has been carefully inspected and packed at the factory, and each end of the link is shipped in a single box. Please check the packing list carefully that all pieces have been received undamaged. If anything is missing contact Telenetics Microwave support at (916) 624-7313.

TRANSIT DAMAGE

Although the units have been carefully packed by the factory, check for possible transit damage. If any damage has occurred in shipping, leave the entire units and packing carton intact and contact the carrier. Telenetics is not responsible for transit damage.

RETURN AUTHORIZATION NUMBER

If it is necessary to return the equipment, it is first necessary to obtain a return authorization number from Telenetics Microwave Communications Group. Please contact customer service at (916) 624-7316 to obtain this authorization number. When contacting Customer Service, you will need your model number, serial number, a responsible technical contact and a description of the problem. Please have this information available when you make your call.

SECTION III PATH REQUIREMENTS

The microwave path must be clear “line of sight”. That is, it must have no obstructions of any kind between the two antennas. Ensure that the path is not obstructed by buildings, trees (allow for growth), billboards, telephone poles, light poles, or any other objects either man-made or natural. A strobe light is often used to verify “line of sight”.

The microwave “beam” does not travel along the path in a parallel fashion, it actually spreads out in the middle of the path and it is possible that a portion of this “spread-out” beam may hit an obstruction. In some cases this may cause multi-path interference.

TOP VIEW

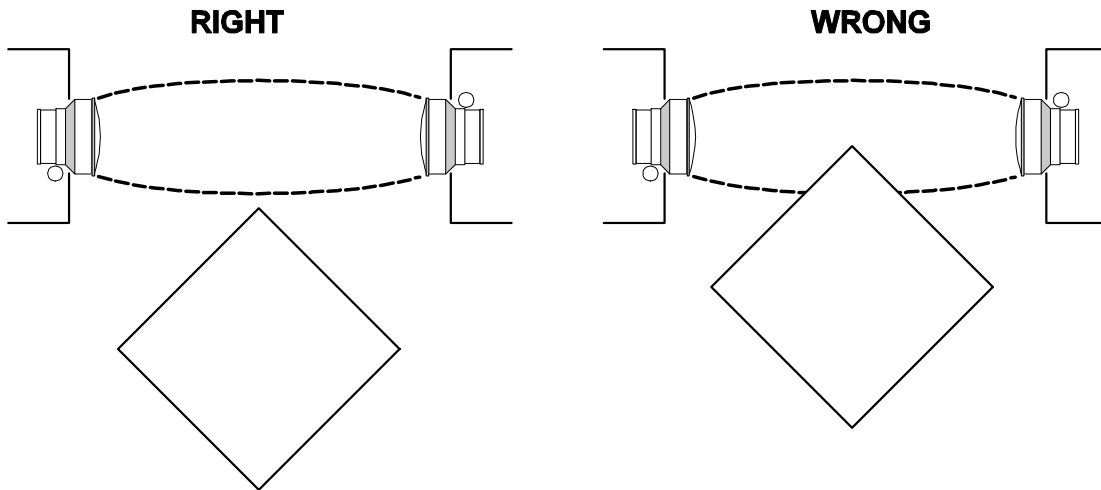

SIDE VIEW

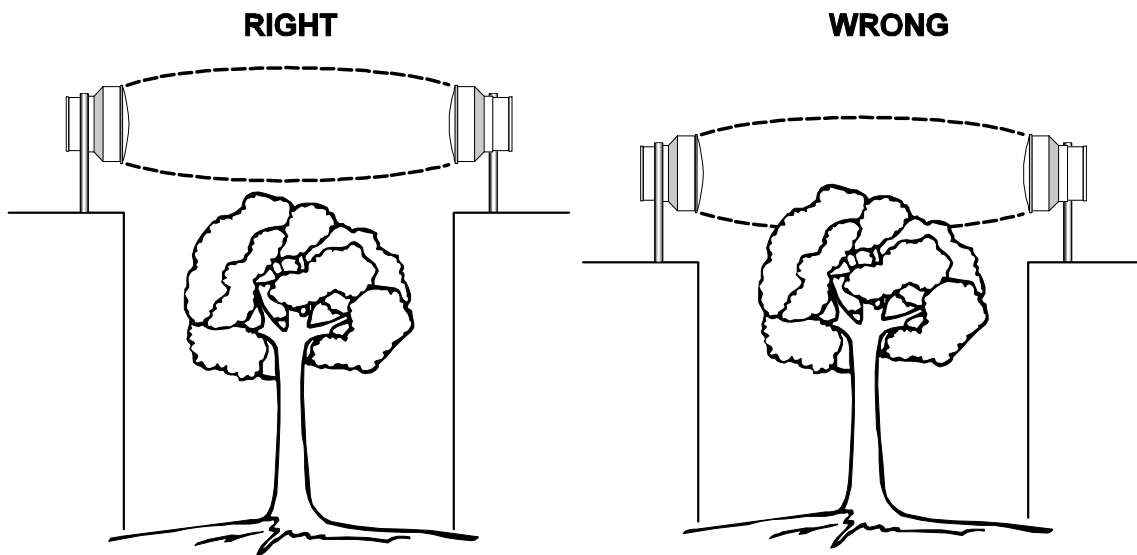

SECTION III
PATH REQUIREMENTS
(Continued)

After the path has been checked, and the antenna height verified, attention should be given to the mounting structures for the RF head units. Telenetics millimeter wave communication radios are designed for easy installation. They will mount to pipes varying in diameter from 2.5 to 4.5 inches. This will accommodate almost all mounting structures available. The structure must be relatively rigid to prevent antenna movement when it is windy. The structure must not vibrate, twist, or sway. If necessary, guy wires may be used to stabilize the structure.

SECTION IV TECHNICAL SPECIFICATIONS

TRANSMITTER CHARACTERISTICS

RF Source	Oscillator/ Multiplier Amplifier Type
Guaranteed Power Output	+17 dBm (minimum)
Power Control Option	7 steps down from max power out
Frequency Stability	0 to +70 C) \pm 0.001%
Tuning Range	21.2 TO 23.6 GHz
	Covers full band with two (2) sets of units(One set covers upper half, one set covers lower half) In response to interference, radios may be tuned in 5 MHz increments at the Control Unit.

RECEIVER CHARACTERISTICS

Type	Dual Conversion Superhetrodyne 2500 & 70 MHz
Noise Figure	5.5 dB (typical)
Video Threshold for 46 dB S/N Ratio	-80 dBm
Sub Carrier Threshold (camera to monitor)	-80 dBm
Sub Carrier Threshold (monitor to camera)	-83 dBm
Maximum receiver input (Damage will occur at +5 dBm)	-15 dBm
Transmit -Receive Separation	1200 MHz

12" ANTENNA CHARACTERISTICS	Type
Type	Parabolic
Diameter	12.5 inches (31.8 cm)
Polarization	Linear
Gain (22.4 GHz)	35 dB
Front to back ratio	42 dB
Beam-width (3 dB)	3.2 Deg

ENVIRONMENTAL CHARACTERISTICS

	RF HEAD	CONTROL UNIT
Ambient temperature range	-30 to +70 C	0 to +50 C
Storage & transportation	-40 to +80 C	-40 to +60 C
Humidity	up to 100% (non-condensing)	up to 95% at +50C (non-condensing)

INPUT VOLTAGE REQUIREMENTS

Power input	93 - 265 VAC
Brown-out voltage	90 VAC
Line frequency	50 - 60 Hz

POWER CONSUMPTION

Total power required per Terminal 50 Watts Maximum
100 Watts maximum for both

FCC INFORMATION

FCC Rules Part number	101
Frequency Range	21.2 - 23.6 GHz**
Emission Designator	25M0F8W
Frequency Tolerance	+/- 0.001%
FCC Maximum Power Output	0.10 watts

SIZE AND WEIGHT

	High	Deep	Wide	Wt
Outdoor RF Unit with Integrated 12" antennas (excluding mount)	15"	12"	15"	15 lb.
Outdoor RF Unit for use with external antennas (excluding mount)	11"	8"	6"	15 lb.

RF unit mounts to 2.5" to 4.5" pipe, for integral 12" antenna configuration, mount for vertical polarization is supplied with unit.

Indoor Interface Unit 19" Rack, 2RU mounting space (3.5" high)

CUSTOMER INTERFACE CONNECTIONS

Cabling for RS422	2 shielded, twisted pair
Control Cabling Connectors	DB9
Video Cabling (Radio/Camera/Monitor)	RG-59U(75 Ohm)

RF HEAD TO CONTROL UNIT

Coax Cable , Head to Control Unit	50 Ohm, Belden 9913
Coax Cable Connectors	Type N
DC Power cable (0 to 1,000' separation)	Spade Lugs
Power Connector at RF Head	7Pin Waterproof CPC
Power Connector at Control Unit	Terminal Strip

**FREQUENCIES

The lower half of the band is covered by one pair of units and the upper half of the band is covered by a second pair of units.

* Specifications are subject to change without notice.

SECTION V PRELIMINARY INSTALLATION CONSIDERATIONS

Prior to receiving the radio equipment, there are a number of preliminary tasks which should be completed. Proper site preparation will significantly expedite the final installation process.

1. Determine the exact sites where the radio equipment will be located.
2. Ensure that the tower or mounting structure is adequate to support the RF head unit, and that line of sight exists between the antenna points, please refer to Section III, Path Requirements. Note that the mounting point must be stiff enough to hold the pointing within +/- 3.2 degrees.
3. Perform the path survey.
4. Obtain the necessary ancillary equipment (interconnect cable, connectors, etc.), and determine any special installation requirements.
5. Ensure that appropriate power is available.
6. Install the interconnect cable runs between the Outdoor RF Heads, the video equipment, the data network, and the Indoor Control Units.

SECTION VI INSTALLATION INSTRUCTIONS

General:

The Telenetics 2321A Video radio link consists of two terminals, each consisting of two units ...the Outdoor RF Head and the Indoor Control Unit. The 2321A RF Head is pole mounted and consists of the microwave antenna, transmitter/receiver, baseband signal modulator, and an IF down-converter. The Control Unit is mounted in an indoor enclosure at street level and contains the video and data network interface circuitry and power supplies which power both the Control Unit and the RF Head. Input power to the link is 96-265 VAC applied at the Control Unit or, as options 24 or 48 VDC.

The RF Head is connected to the Control Unit by a single 50 Ohm coaxial cable and a 5-wire DC power cable. These cables may be up to 1000 feet long. The Radio Link is electrically connected, through the Control Unit, to the video equipment by an RG-59/U, 75 Ohm, coaxial cable terminated with a BNC male connector that attaches to the female BNC bulkhead connector on the Control Unit, and a 6 wire cable (2 shielded twisted pair and the 2 shields) that attaches to the female DB9 bulkhead connector on the Control Unit.

Items Required for Installation:

Tools/Test Equipment:

- 3/4" wrench to adjust antenna elevation angle
- Wrench sized for customer supplied U-clamp
- Tool to install cable connectors
- 2 ea Fluke 73 series II multimeter or equivalent
- 1 ea Leader LCG-400 NTSC Pattern Generator or equivalent
- 1 ea Video receiver
- 1 ea HP1645A Data Error Analyzer or equivalent
- 1 ea Reliable Communications Model RSP 584 or equivalent (RS232 to RS422 Converter)
- 1 ea RS422 loop back cable

Customer Furnished items:

- 2 ea U-Clamps (2.5" to 4.5" diameter) for pole mount
- As required Interconnect cables and connectors
- As required Cable ties

SECTION VI
INSTALLATION INSTRUCTIONS
(continued)

Telenetics furnished items:

1 ea	“A” RF Head Unit	(Video Transmitter)
1 ea	“A” Control Unit	(Video Transmitter)
1 ea	“B” RF Head Unit	(Video Receiver)
1 ea	“B” Control Unit	(Video Receiver)
2 ea	Mounting brackets	(p/n 380-00062-0001)

Radio Installation

1. Install 50 Ohm coaxial cables, with Male Type N connectors attached, and 5-wire power cables, with the 7 pin AMP CMC connectors attached to the RF Head end of the cables and spade lugs attached to the Control Unit end of the cables, between the RF Head locations and the Control Unit locations. Install the 75 Ohm coaxial cables, with Male BNC connectors attached, from the location of the Female Bulkhead BNC connectors on the back of the Control Units to the user video equipment. Attach the Male DB9 connectors to the 6-wire (2 twisted pair and the 2 shields) data network interface cables and run them from the location of the Female Bulkhead DB9 connectors on the back of the Control Unit and the user data network.

2. Proceed to install the 2321A RF Heads and Control Units. The RF head should be mounted with the water drain holes facing down. **If this is not done the unit may fill with water, and the warranty will be voided.**
 - A. Determine desired 2321A RF head orientation for correct antenna polarization at both ends of the link. Make sure the feed polarization is the same at both ends.
 - B. Mount RF head so both horizontal and vertical mounting angle can be easily adjusted during the antenna alignment process.
 - C. Connect interconnect cables to the RF Head Unit at each end of link. Apply power to the RF Head Units through the Control Units at both ends of the radio link. Open the RF head unit. LED indicators should be on. If no LED's are on, check the connections for AC (or DC) power.

SECTION VI
INSTALLATION INSTRUCTIONS
(continued)

- D. Antenna alignment requires a person with a communication device (Cellular Phone, Walkie-Talkie, et.) at each end of the link. Visually align antennas at each other. Hold one antenna still. Place the ground lead of the multimeter into the black tip jack on the RF head and the red lead into the red tip jack on the RF head. Monitor the AGC voltage at the far end and move the near end antenna very slowly from side to side to find the maximum AGC voltage. There may be more than one peak, (but only one large one) so make sure the arc is large enough to ensure that the maximum voltage is achieved. Tilt the antenna a little up or down with each horizontal sweep. After an AGC of +4 volts or more is established at each end; adjust antennas very slightly left to right and up to down to find the maximum AGC voltage at both ends.

- 3. Attach test equipment and do a loop back test on the data channel. Link should operate correctly. If not, check wiring between test equipment and radio.

- 4. The installation is complete.

SECTION VII INSTALLATION DRAWINGS

REVISIONS			
LTR	ECO	DESCRIPTION	DATE
D		CHG THK	3-14-94
E	00293	CHG THK	

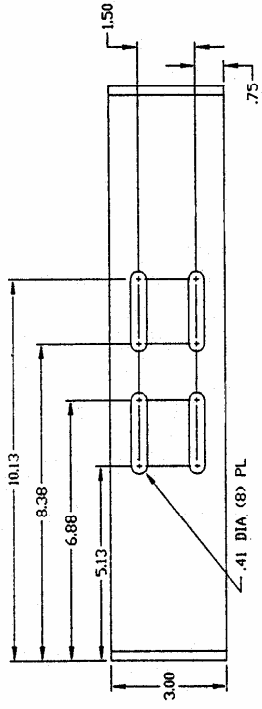
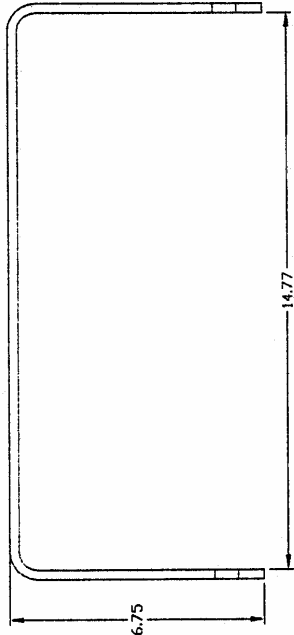
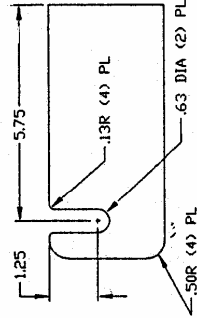
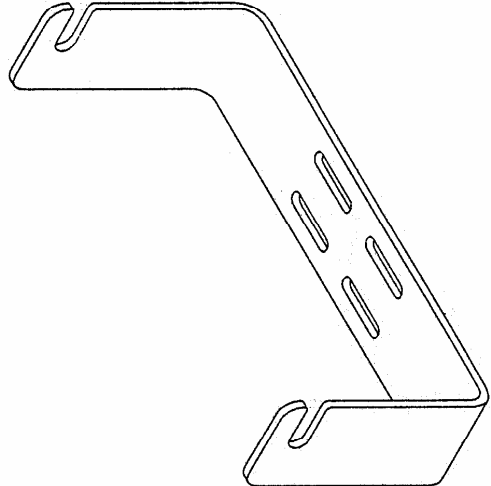

- NOTES (UNLESS OTHERWISE SPECIFIED)
1. MATERIAL - AL 5052-H32 .25 THK
 2. ALL DIMENSIONS IN INCHES
 3. TOLERANCE - XX±.02
 4. MINIMUM BEND RADIUS: BREAK ALL SHARP EDGES
 5. FINISH - CHEMICAL FILM PER MIL-C-5541 TYPE 1, GRADE C, CLASS 3, CLEAR

PROPRIETARY NOTICE INFORMATION CONTAINED IN THIS DOCUMENT IS PROPRIETARY IN NATURE, AND IS NOT TO BE COPIED OR DISCLOSED WITHOUT THE WRITTEN CONSENT OF SIERRA DIGITAL COMMUNICATIONS	APPROVALS J. STIGNER	DATE 6-10-93	SIERRA DIGITAL COMMUNICATIONS
	APPROVALS J. STIGNER	DATE 6-10-93	MOUNTING BRACKET, STOPLIGHT HOUSING DWG: 380-00062-0001 SCALE: 1:1 REV: E FILE: 00062E.DWG SHEET: 1

SECTION VII INSTALLATION DRAWINGS Continued

AMP Connector Detail for DC Power Cable
Flange Receptacle on RF Head
Plug on 5-Wire Power Cable from Control Unit to RF Head

AMP

**Metal-Shell
CPC Connectors
Series 1
Standard Sex Connectors**

Part numbers are for connectors only;
order contacts separately (see pages
2050, 2051).



Square Flange Receptacle
(Accepts Multimate Pins)

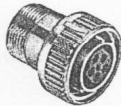

Plug
(Accepts Multimate Sockets)

Note: Size 14 Housing O.D. Dim. (Typ.)—1.031 [26.19]

Arrangement	Square Flange Receptacle	Part Numbers	
		Plug w/o TETRASEAL	Plug with TETRASEAL
14-5	208719-1	208718-1	208718-2
14-7	208715-1	208714-1	208714-2
22-16	208489-1	208488-1	208488-3
28-24	208459-1	208457-1	208457-3
28-37	208471-1	208470-1	208470-3

Note: Maximum wire insulation diameter is .100 [2.54] max., except arrangements 14-5 and 28-24 which are .150 [3.81] max.

Part # 208715-1 on RF Head (furnished)

Part # 208714-1 on Cable (furnished)
(cable sealing back shell also furnished)

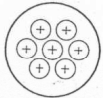

Arrangement 14-7
Max. Wire Ins. Dia = .100 [2.54]

PIN #	Function
1	+ DC Volts
2	+ DC Volts
3	Not Used
4	- DC Volts
5	- DC Volts
6	Not Used
7	Ground

SECTION VII
INSTALLATION DRAWINGS
 Continued

Frequency Select Switch Settings
 for Various Operating Frequencies

Frequency Pair	"A" Head		"B" Head	
	Higher Frequency of Pair	Lower Frequency of Pair	Higher Frequency of Pair	Lower Frequency of Pair
Frequency Pair	Frequency Start at 22.405 GHz	Switch Setting 500s - 50s - 5s	Frequency Start at 21.205 GHz	Switch setting 500s - 50s - 5s
H	21.225	0 - 0 - 4	22.425	0 - 0 - 4
I	21.275	0 - 1 - 4	22.475	0 - 1 - 4
J	21.325	0 - 2 - 4	22.525	0 - 2 - 4
K	21.375	0 - 3 - 4	22.575	0 - 3 - 4
L	21.425	0 - 4 - 4	22.625	0 - 4 - 4
M	21.475	0 - 5 - 4	22.675	0 - 5 - 4
N	21.525	0 - 6 - 4	22.725	0 - 6 - 4
O	21.575	0 - 7 - 4	22.775	0 - 7 - 4
P	21.625	0 - 8 - 4	22.825	0 - 8 - 4
Q	21.675	0 - 9 - 4	22.875	0 - 9 - 4
R	21.725	1 - 0 - 4	22.925	1 - 0 - 4
S	21.775	1 - 1 - 4	22.975	1 - 1 - 4

UPPER HALF OF THE FULL 23 GHZ BAND

Frequency Pair	"A" Head		"B" Head	
	Higher Frequency of Pair	Lower Frequency of Pair	Higher Frequency of Pair	Lower Frequency of Pair
Frequency Pair	Frequency Start at 23.005 GHz	Switch Setting 500s - 50s - 5s	Frequency Start at 21.805 GHz	Switch setting 500s - 50s - 5s
D*	21.825	0 - 0 - 4	23.025	0 - 0 - 4
T*	21.875	0 - 1 - 4	23.075	0 - 1 - 4
G*	21.925	0 - 2 - 4	23.125	0 - 2 - 4
E*	21.975	0 - 3 - 4	23.175	0 - 3 - 4
C	22.025	0 - 4 - 4	23.225	0 - 4 - 4
U	22.075	0 - 5 - 4	23.275	0 - 5 - 4
V	22.125	0 - 6 - 4	23.325	0 - 6 - 4
B	22.175	0 - 7 - 4	23.375	0 - 7 - 4
X	22.225	0 - 8 - 4	23.425	0 - 8 - 4
Y	22.275	0 - 9 - 4	23.475	0 - 9 - 4
F	22.325	1 - 0 - 4	23.525	1 - 0 - 4
A	22.375	1 - 1 - 4	23.575	1 - 1 - 4

* FCC regulations reserve frequency pairs D, T, G, E for low power links with EIRP of 55 dBm max

SECTION VII
INSTALLATION DRAWINGS
Continued

Line Build-Out Switch Settings
for Various RF Head to Control Unit Separations

Head to Control Unit Separation	Switch # 1	Switch # 2
0 to 250 Feet	OFF	OFF
250 to 500 Feet	ON	OFF
500 to 750 Feet	OFF	ON
750 to 1,000 Feet	ON	ON

SECTION VII
INSTALLATION DRAWINGS
Continued

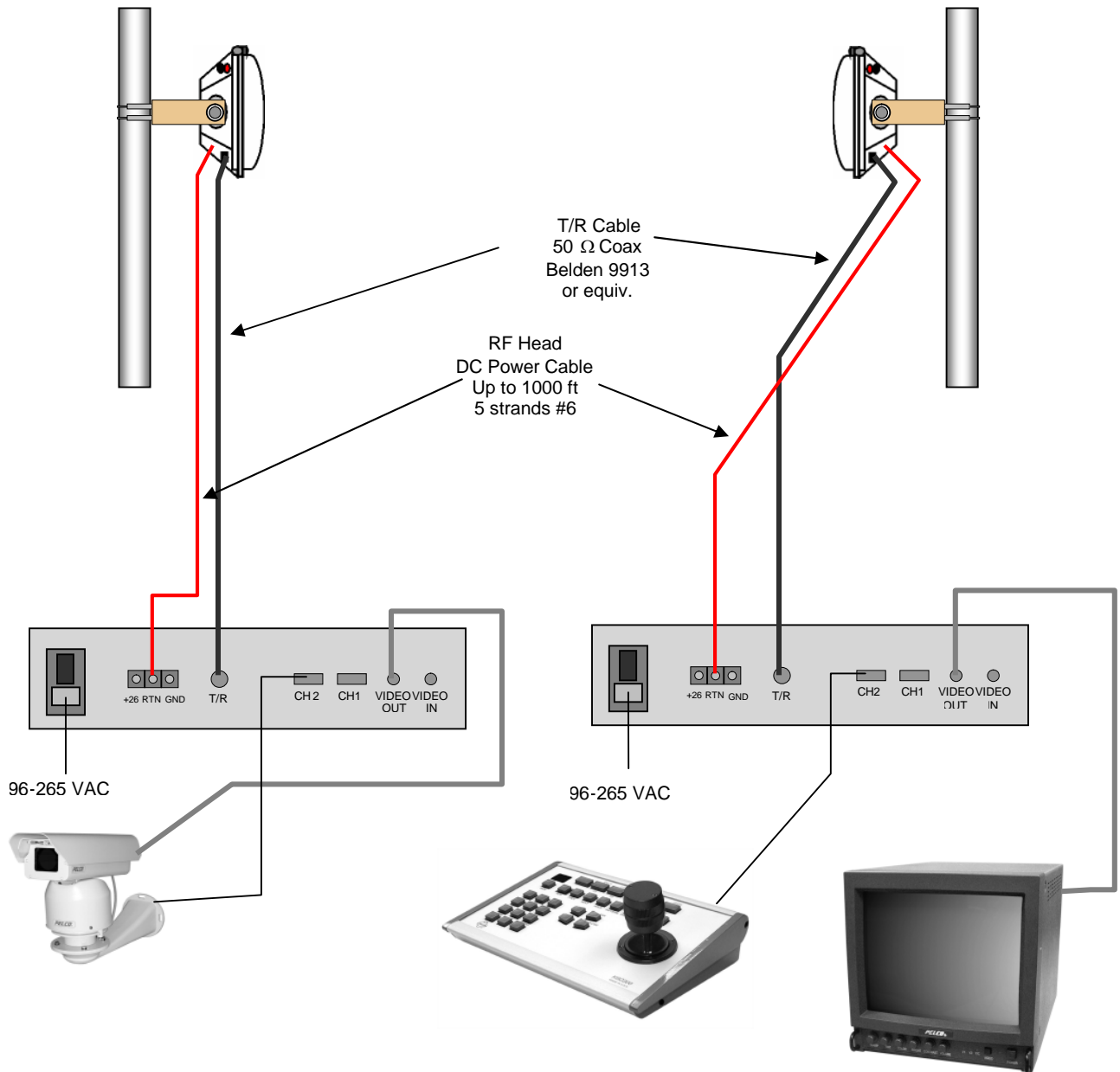

SECTION VIII LIMITED WARRANTY

Seller warrants to the Buyer that all Seller goods (equipment and component parts) when sold are free from defects in materials and workmanship under normal use and service for a period of one year from the date of shipment, as evidenced by Seller's or its agent's packing list or transportation receipt. Seller's obligation under this warranty shall be limited to the repair or replacement of goods. No person, including any dealer, agent or representative of Seller, is authorized to assume for Seller any other liability on its behalf.

Seller has no obligation or responsibility for goods, which have been repaired or altered by other than Sellers employees.

This warranty is the only warranty made by seller and is expressly in lieu of all other warranties express or implied, and warranties of merchantability and fitness for any particular purpose are specifically excluded.

WARRANTY CLAIM PROCEDURES

Defective goods must be returned, transportation charges prepaid, to seller for correction. Seller will pay return transportation charges for warranty repair. Upon redelivery of goods corrected under this warranty, the repaired or replaced portions shall be subject to this warranty for a period of 90 days or until expiration of the original warranty, whichever is later. All claims of failed or defective goods must be in writing and received by Seller within the specified warranty period. Seller will provide Buyer a return authorization number as authority to return the goods and for use in monitoring repair status.

Repair or replacement of defective goods will be at Seller's discretion and for the Buyer's account when the cause of failure is determined by Seller's examination to be misuse, mishandling or abnormal conditions of operation. In such event a firm price quotation for correction of the goods may be submitted to the Buyer. No repair or replacement work will be initiated prior to receipt of the Buyer's written authorization to proceed and approval of price, except as may be necessary to complete Seller's examination of the goods. If returned goods are determined not to be defective or if the Buyer elects not to authorize correction at its expense of goods not covered by its warranty, the Seller may charge a reasonable amount for such evaluation. Any amounts due Seller under these conditions will be subject to the same payment terms as the original sale. The Buyer will not recover from Seller by offset, deduction or otherwise, the price of any goods returned to Seller under this warranty.

REPAIR AND RETURN PROCEDURE

A return authorization number must be obtained from Telenetics before any items will be accepted for repair or return. Please contact the Telenetics Customer Service organization at (916) 624-7313 to obtain this authorization number. When contacting Customer Service, you will need your Model number, Serial number, a Purchase Order number (if out of warranty), a responsible technical contact, and a description of the problem. Please have this information available prior to calling.

SECTION IX GLOSSARY OF MICROWAVE RADIO TERMS

This glossary of microwave radio terms is offered in the belief that it will aid in the understanding of the application of Telenetics microwave Communications radios.

A.G.C.

Automatic Gain Control voltage, which indicates the relative signal strength of the microwave carrier; used to align the RF head during installation; also useful in determining the status of the microwave link

ALARM

An indication of an error condition

AUXILIARY SUBCARRIER

An extra carrier for a specialized circuit

BANDWIDTH

The portion of the frequency spectrum, expressed in Hertz, required for the transmission of one or more signals.

BASEBAND (BB)

The band of frequencies occupied by the signal before it modulates the carrier (or sub carrier) frequency.

BIT ERROR RATE (BER)

The ratio of erroneous bits to total bits received in a specified measurement interval; equivalently, the bit errors per second divided by the data rate in bits per second.

CARRIER

A high frequency signal which may be varied from a known reference by modulation.

C.C.I.R. (International Radio Consultative Committee)

International Standards Committee covering the radio transmission of information; a committee of the International Telecommunications Union (ITU) Geneva Switzerland.

CHANNEL

The pair of frequencies used by the two RF heads within a link to transmit data between them.

INTERFACE UNIT

The ground level equipment used to interface between the users equipment and the RF head; contains a power supply and interface board(s)

LED

Light Emitting Diode; a solid state lamp used to indicate status

LINK

Two RF heads or antennas, separated by some distance, which communicate with each other.

MODEM

A contraction of modulator-demodulator

PATH

The physical airspace between the two antennas

PULSE CODE MODULATION (PCM)

An encoding rather than a modulation technique in which quantized samples of analog information are buffered and retimed. Digital data are transmitted in the form of binary words, each consisting of a fixed number of bits. These PCM data words are arranged in a single serial bit stream by the data source and fed to the communications channel in continuous uniformly timed fashion. Normally word identification bits and synchronization bits are mixed with the data words in a regular and predetermined pattern.

R.F. HEAD (HEAD)

In the case of the 31 GHz unit, a pole mounted transmitter-receiver-antenna assembly. In the case of the 23 GHz and 18 GHz units, the antenna is not supplied.

SUMMARY ALARM

A single alarm that indicates that one of several alarms has occurred, may be tied to a common office alarm.