

DSP9612RM Flash Poll Rack-Mount Modem User's Guide

The products and programs described in this User's Guide are licensed products of Raymar Information Technology, Inc. This User's Guide contains proprietary information protected by copyright, and this User's Guide and all accompanying hardware and documentation are copyrighted.

Raymar Information Technology, Inc. does not warrant that the hardware will work properly in all environments and applications, and makes no warranty and representation, either implied or expressed, with respect to the quality, performance, merchantability, or fitness for a particular purpose.

Information in this User's Guide is subject to change without notice and does not represent a commitment on the part of Raymar Information Technology, Inc. Raymar Information Technology, Inc. assumes no responsibility for any inaccuracies that may be contained in this User's Guide.

Raymar Information Technology, Inc. makes no commitment to update or keep current the information in this User's Guide, and reserves the right to make changes to this User's Guide and/or product without notice.

No part of this manual may be reproduced or transmitted in any form or by any means, electronic or mechanical, including photocopying, recording, or information storage and retrieval systems, for any purpose other than the purchaser's personal use, without the express written permission of Raymar Information Technology, Inc.

© Copyright 2010
Raymar Information Technology, Inc.
7325 Roseville Road
Sacramento, California 95842
Tel: 800-695-1951
Direct: (916) 783-1951
Fax: (916) 783-1952

Compliances

This device complies with Part 15A of the FCC Rules. Operation is subject to the following two conditions: (1) this device may not cause harmful interference, and (2) this device must accept any interference received, including interference that may cause undesired operation.

This equipment has been tested and found to comply with the limits for a Class A digital device, pursuant to Part 15A of the FCC Rules. These limits are designed to provide reasonable protection against harmful interference in a residential installation. This equipment generates, uses, and can radiate radio frequency energy and, if not installed and used in accordance with the instructions, may cause harmful interference to radio communications. However, there is no guarantee that interference will not occur in a particular installation. If this equipment does cause harmful interference to radio or television reception, which can be determined by turning the equipment off and on, the user is encouraged to try to correct the interference by one or more of the following measures:

- ❖ Reorient or relocate the receiving antenna.
- ❖ Increase the separation between the equipment and the receiver.
- ❖ Connect the equipment to an outlet on a circuit other than the one to which the receiver is connected.
- ❖ Consult the dealer or an experienced radio/TV technician for help.

If none of these actions resolves the problem, consult your distributor or an experienced radio/television technician for additional suggestions.

Additionally, Section 15.838, paragraph d), of the FCC Rules and Regulations states: “Where special accessories, such as shielded cables, are required in order to meet FCC regulations, shielded cables must be used with this equipment. Operation with non-approved equipment or unshielded cables is likely to result in interference to radio and TV reception. The user is cautioned that changes and modifications to this equipment without the approval of the manufacturer could void the user’s authority to operate this equipment.

Contents

CHAPTER 1 INTRODUCTION	1
FEATURES	2
APPLICATIONS	2
ANCILLARY DOCUMENTATION.....	3
CHAPTER 2 INSTALLATION	4
UNPACKING YOUR HARDWARE	4
ADDITIONAL ITEMS YOU NEED.....	4
HARDWARE OVERVIEW	4
<i>Front View</i>	4
<i>Component View</i>	5
INSTALLATION SUMMARY	7
CONFIGURING THE MODEM.....	7
<i>SW1 DIP Switch Settings</i>	8
<i>SW2 DIP Switch Settings</i>	11
<i>SW3 DIP Switch Settings</i>	14
INSTALLING THE MODEM.....	18
CONNECTING TO A TRANSMISSION LINE	19
<i>Modular Jack Connectors</i>	19
<i>Mass Termination Connector</i>	20
CONNECTING AN RS-232 DEVICE	20
LEDS	21
LOOPBACK CONTROL SWITCH	21
APPENDIX A TROUBLESHOOTING.....	27
PROBLEM SOLVING	27
APPENDIX B SPECIFICATIONS	24
GENERAL SPECIFICATIONS.....	24
MECHANICAL SPECIFICATIONS	25
BACK-TO-BACK CONNECTIONS TO A SECOND MODEM.....	26
<i>RS-232 (RTU) Interface</i>	26
ENVIRONMENTAL SPECIFICATIONS	27
APPENDIX C LIMITED PRODUCT WARRANTY...28	
APPENDIX D RMA PROCEDURE	29

Chapter 1

Introduction

Congratulations for purchasing the finest industrial-grade fast-poll rack-mount modem available.

The Raymar-Telenetics DSP9612RM (Flash Poll) modem is a 9600/4800/0-1800 bps rack-mount modem designed for 4-wire, full-duplex or 2-wire, half-duplex operation over a voice-band leased line. The modem is designed utilizing the latest digital-signal processing (DSP) technology to achieve high performance. The modem employs Raymar-Telenetics' proprietary modulation and encoding scheme to achieve fast modem training time. It is also backward compatible with Bell 202 modems.

The modem can be installed in an RM16M Rack (16 slots, 3U) or the RMX Shelf (2 slots, 1U) from Raymar-Telenetics. The modem occupies only one rack slot, eliminating the hassle of equipment trays and power bricks required for "Stand Alone" modems. The modem is powered from the modem rack.

The DSP9612RM modem is ideally suited for multi-point communication systems that require fast response time, short training time, and low throughput delay. The modem is the most technologically advanced rack-mount modem on the market.

This User's Guide is designed to let you get your modem "up and running" as quickly as possible. It contains all the information you need to install and configure your modem. It also contains troubleshooting information in the unlikely event you encounter a problem with your modem.

Features

Though functionally similar to commercial modems, the DSP9612RM provides the following unique features that make it well suited for utility and industrial applications.

- ❖ Requires only one rack slot.
- ❖ Operates over voice-band conditioned or unconditioned leased line and pilot wires.
- ❖ Operates without human intervention, making it ideal for unmanned locations.
- ❖ Works within an extended temperature range of -40°C to +85°C.
- ❖ Designed with coupling transformers for high-voltage isolation and common mode noise rejection in industrial and commercial environments.
- ❖ Asynchronous data rates (selectable) of 9600, 4800, and 0-1800 bps.
- ❖ Easily accessible DIP switches for user configuration and option selection.
- ❖ Local analog, local digital, and remote digital loopback diagnostics.

Applications

The DSP9612RM modem is designed for point-to-point and multipoint data communications. Figure 1-1 shows a typical multipoint configuration.

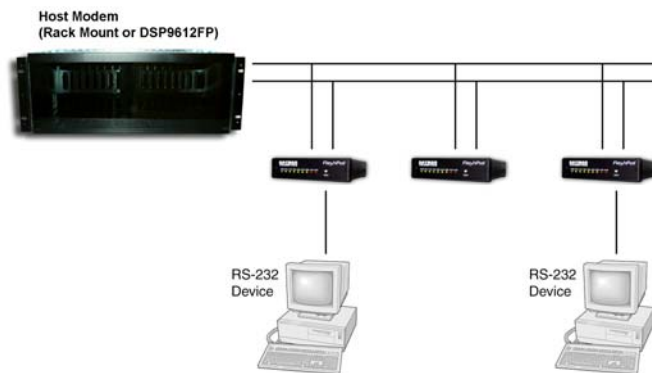

Figure 1-1. Network of Multipoint Configuration

There are a number of factors that can affect the network's and modem's operation and performance. These include:

- ❖ Operating speed
- ❖ 2-wire or 4-wire configuration
- ❖ Transmission line characteristics, noise, and line impairments
- ❖ Network configuration (point-to-point or multipoint)
- ❖ Number of nodes on the network

Ancillary Documentation

For information about how to adapt an AC powered DSP9612RM modem to a DC power operation, refer to the included documents (0062-0117-001). Also refer to the RM16M Installation and Operation Guide (TEL-6200508506004).

Chapter 2

Installation

This chapter describes how to install the modem.

Unpacking Your Hardware

Your package should include:

- ❖ At least one DSP9612RM modem
- ❖ This User's Guide (on CD)

If your package contents are damaged or missing, please contact your place of purchase immediately.

Additional Items You Need

To use your modem, you need the following additional items:

- ❖ An RM16M Rack or an RMX Shelf from Raymar-Telenetics
- ❖ A two- or four-wire transmission line or leased line

Hardware Overview

Front View

Figure 2-1 shows a front view of the DSP9612RM modem. Starting from the top, this view shows:

- ❖ A loopback test switch. See page 21.
- ❖ A set of eight LEDs. See page 21.

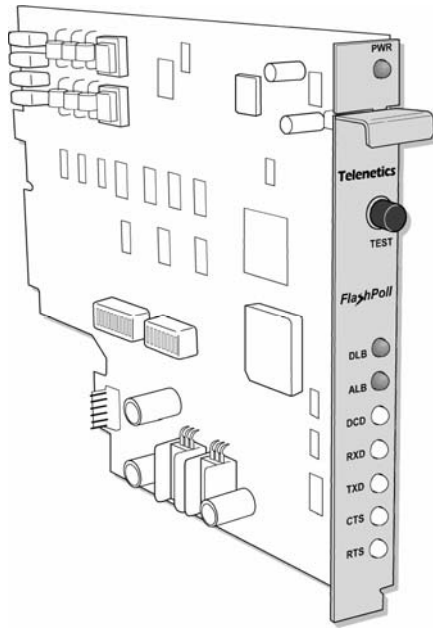

Figure 2-1. Front View of Modem

Component View

Figure 2-2 shows the component view of the modem. This view shows:

- ❖ Three configuration switch blocks, designated **SW1**, **SW2**, and **SW3**. See page 7.
- ❖ Jumpers located in various positions on the modem. Do not change or remove the straps from these jumpers.
- ❖ Edge connectors at the back of the modem, which plug into the backplane of an RMX Shelf or an RM16M Rack from Raymar-Telenetics.

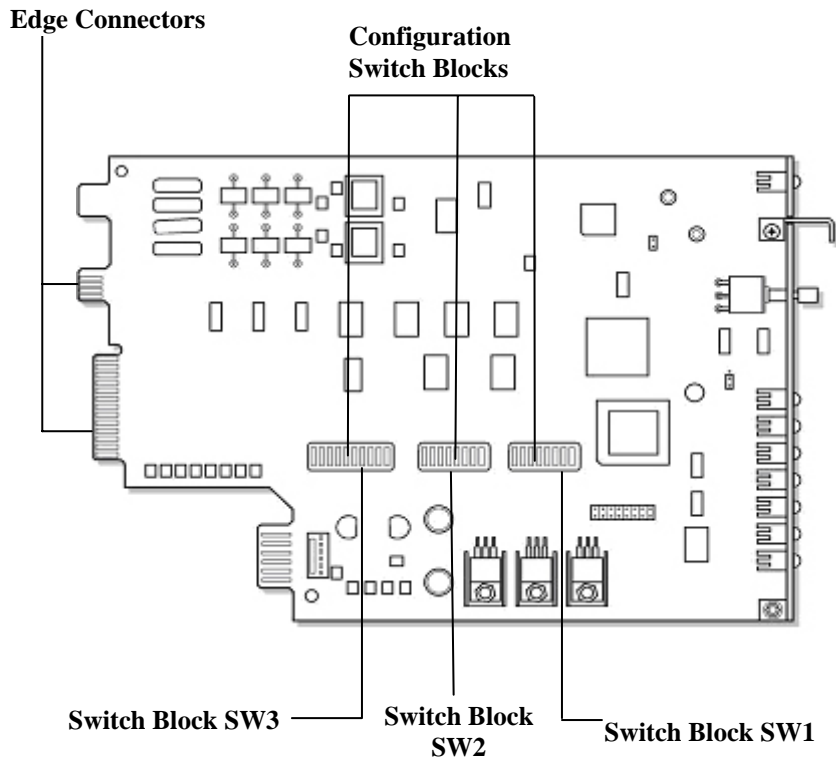

Figure 2-2. Component View of Modem

Installation Summary

The modem installation involves the following steps:

1. Configuring the modem. See below.
2. Connecting to a transmission line. See page 19.
3. Connecting an RS-232 device. See page 20.

Configuring the Modem

You configure the modem using the three sets of DIP switches on the bottom of the modem.



IMPORTANT

It is important to follow the three steps described below, in the order shown, to ensure that you configure your modem properly using the modem DIP switches:

1. Use DIP switch 3 (SW3) to configure the modem for your host DTE interface and network topology. Using SW3, you select the modem to operate in high-speed fast-poll or low-speed (FSK) mode.
 2. If you set SW3 for FSK mode in step 1, use DIP switch 2 (SW2) to configure the modem for either Bell 202T or ITU-T V.23 compatibility. Otherwise, you can use the modem in fallback mode.
 3. Use DIP switch 1 (SW1) to select the modem's transmitter output level and receiver dynamic range. The SW1 settings apply for both high-speed fast-poll and low-speed (FSK) modes.
-

Model: DSP9612
P/N: 0053-0117-003

SW1 Function		Off/On	SW2 Function		Off/On	SW3 Function		Off/On			
1	<input type="checkbox"/>	1: Tx level	bit 1 (msb)	1	<input type="checkbox"/>	1: FSK Mode	B 202/V23	1	<input type="checkbox"/>	1: Modulation	QAM/FSK
2	<input type="checkbox"/>	2: Tx level	bit 2	2	<input type="checkbox"/>	2: Rx Sq	0/8 ms (150)	2	<input type="checkbox"/>	2: BPS(QAM)	9600/4800
3	<input type="checkbox"/>	3: Tx level	bit 3	3	<input type="checkbox"/>	3: Soft Carrier	en/disable	3	<input type="checkbox"/>	3: Data format	10/11 bits
4	<input type="checkbox"/>	4: Tx level	bit 4 (lsb)	4	<input type="checkbox"/>	4: RTS-CTS	8/33 ms	4	<input type="checkbox"/>	4: RTS CTRL	normal/auto
5	<input type="checkbox"/>	5: Rx Range	-30/43dBm	5	<input type="checkbox"/>	5: RTS-CTS	59/219 ms	5	<input type="checkbox"/>	5: TX Term	600 ohms/sw
6	<input type="checkbox"/>	6: Tx Equ.	dis/enable	6	<input type="checkbox"/>	6: CD Delay	6/23 ms	6	<input type="checkbox"/>	6: Reserved	always off
7	<input type="checkbox"/>	7: Rx Equ.	dis/enable	7	<input type="checkbox"/>	7: R. Loopback	dis/enable	7	<input type="checkbox"/>	7: 2/4 - wire	4 wire/2 wire
8	<input type="checkbox"/>	8: Anti Stream	dis/enable	8	<input type="checkbox"/>	8: Reserved	(off)	8	<input type="checkbox"/>	8: Tx carrier	sw/const
								9	<input type="checkbox"/>	9: RX Term	Hi Z/600 ohms
								10	<input type="checkbox"/>	10: SG-Align	open/close

SW1 DIP Switch Settings

SW1 is an 8-position DIP switch. Table 2-1 shows the modem switch settings for DIP switch SW1. A description of the SW1 switch settings follows the table.

Note: SW1 settings apply for both high-speed fast-poll and low-speed (FSK) modes

Table 2-1. Modem Switch Settings for DIP Switch SW1

Switches	Switch Settings	
	ON	OFF (Default)
SW1-1 – SW1-4: Transmit Level (page 9)	(see Table 2-2 on page 9)	
SW1-5: Receiver Dynamic Range (page 10)	-10 to -43 dBm	+3 to -30 dBm
SW1-6: TX Cable Equalizer (page 10)	Enabled	Disabled
SW1-7: RX Cable Equalizer (page 10)	Enabled	Disabled
SW1-8: Anti-streaming (page 10)	Active	Inactive

SW1-1 through SW1-4 – Transmit Level

Switches SW1-1 through SW1-4 adjust the modem's transmit level. Table 2-2 shows the transmit levels you can select using these switches.

Table 2-2. Transmit Levels

Transmit Level	SW1 through SW4 Switch Settings			
	SW1-1	SW1-2	SW1-3	SW1-4
0 dBm	OFF	OFF	OFF	OFF
-1 dBm	OFF	OFF	OFF	ON
-2 dBm	OFF	OFF	ON	OFF
-3 dBm	OFF	OFF	ON	ON
-4 dBm	OFF	ON	OFF	OFF
-5 dBm	OFF	ON	OFF	ON
-6 dBm	OFF	ON	ON	OFF
-7 dBm	OFF	ON	ON	ON
-8 dBm	ON	OFF	OFF	OFF
-9 dBm	ON	OFF	OFF	ON
-10 dBm	ON	OFF	ON	OFF
-11 dBm	ON	OFF	ON	ON
-12 dBm	ON	ON	OFF	OFF
-13 dBm	ON	ON	OFF	ON
-14 dBm	ON	ON	ON	OFF
+3 dBm	ON	ON	ON	ON

SW1-5 – Receiver Dynamic Range

SW1-5	ON = -10 to -43 dBm OFF = +3 to -30 dBm
-------	--

For a low receive signal level, set SW1-5 to ON (-43 dBm). For short distances or to select a strong receive signal, set SW1-5 to OFF.

SW1-6 and SW1-7 – Cable Equalizer (Fast-Poll Mode Only)

SW1-6	ON = Enable TX Cable Equalizer OFF = Disable TX Cable Equalizer
SW1-7	ON = Enable RX Cable Equalizer OFF = Disable RX Cable Equalizer

To improve or extend the modem's polling performance, use the fixed Compromise Cable Equalizer when polling on long metallic circuits. The cable equalizer is active only when the modem is in fast-poll mode (SW3-1 set to OFF).

SW1-8 – Anti-streaming

SW1-8	ON = Anti-streaming active OFF = Anti-stream inactive
-------	--

Typically, anti-streaming is used in multi-point applications to prevent a malfunctioning slave modem from occupying the line indefinitely. When anti-streaming is active, the modem can transmit data for a maximum of 27 seconds before the transmitter turns off automatically. The modem then looks for an ON-to-OFF Request To Send (RTS) transition before proceeding with normal operation. Anti-streaming can be selected in either high-speed or low-speed mode.

SW2 DIP Switch Settings

SW2 is an 8-position DIP switch. Table 2-3 shows the modem switch settings for DIP switch SW2. A description of the SW2 switch settings follows the table.

Table 2-3. Modem Switch Settings for DIP Switch SW2

Switches	Switch Settings	
	ON	OFF (Default)
SW2-1: FSK Mode (page 12)	V.23	Bell 202
SW2-2: Receiver Squelch (page 12) (valid for FSK mode, 2-wire half-duplex operation only)	Turnaround Squelch (Bell 202): 8ms Turnaround Squelch (V.23): 150ms	Turnaround Squelch (Bell 202): 0ms Turnaround Squelch (V.23): 0ms
SW2-3: FSK Soft Carrier (page 13)	Disabled	Enabled
SW2-4 and SW2-5: FSK RTS-CTS Delay (page 13)	(see Table 2-4)	
SW2-6: FSK CD Delay (page 13)	23ms	6ms
SW2-7: Remote Loopback (page 14)	Enabled	Disabled
SW2-8: Reserved (Test Only) (page Error! Bookmark not defined.)	Test	Normal

SW2-1 — FSK Mode

SW2-1	ON = ITU-T V.23 mode OFF = Bell 202 mode
-------	---

The modem has two FSK modes:

- ❖ Bell 202, which supports data rates from 0 to 1800 bps
- ❖ ITU-T V.23, which supports data rates from 0 to 1200 bps

SW2-1 configures the modem for either of these FSK modes. Setting SW2-1 to ON selects ITU-T V.23 mode. In this mode, the modem complies with ITU-T (CCITT) recommendation V.23 with the following parameters:

- ❖ Mode 2 modulation only
- ❖ No backward channel
- ❖ No provisions for disablement of echo suppressors
- ❖ DTR (circuit 108) is ignored

Setting SW2-1 OFF selects Bell 202 mode.

SW2-2 — Receiver Squelch (FSK Mode 2-Wire Half-Duplex Only)

SW2-2	ON = 8ms for Bell 202, 150ms for ITU-T V.23 OFF = 0ms
-------	--

SW2-2 configures the turnaround squelch delay and is valid when the following are active:

- ❖ FSK mode (SW3-1 ON)
- ❖ 2-wire half-duplex operation (SW3-7 ON)

Setting this switch to OFF configures the modem to enable its receiver immediately after the Request To Send (RTS) signal is turned off. When this switch is set to OFF and the modem is configured for 2-wire, half-duplex mode (SW3-7 ON), the modem squelches the receiver after RTS is turned off to prevent far-end echoes from causing data errors. The duration that the modem squelches the receiver is either:

- ❖ 8 milliseconds if the modem is configured for Bell 202 mode (SW2-1 OFF)
- ❖ 150 milliseconds if the modem is configured for ITU-T V.23 mode (SW2-1 ON)

SW2-3 — FSK Soft Carrier (Bell 202 FSK Mode Only)

SW2-3	ON = None OFF = 8ms
-------	------------------------

SW2-3 controls the soft carrier and is valid for Bell 202 FSK mode only (SW2-1 set to OFF). Setting this switch to OFF configures the modem to transmit a 900 Hz soft carrier to the remote modem for 8 milliseconds after RTS is turned off. Setting this switch to ON prevents the modem from transmitting a soft carrier after RTS is turned off.

SW2-4 and SW2-5 — RTS-CTS Delay (Bell 202 Mode Only)

Switches SW2-4 and SW2-5 determine the duration of the RTS-CTS delay in Bell 202 mode. Table 2-4 shows how to set these switches to select the appropriate setting.

Table 2-4. RTS-CTS Delay Settings in Bell 202 Mode

To Select a Delay of...	Set SW2-4 to...	And Set SW2-5 to...
8ms	OFF	OFF
33ms	OFF	ON
59ms	ON	OFF
219ms	ON	ON

When the modem is configured for V.23 operation (SW2-1 ON), the RTS-CTS delay is fixed at 33 ms.

SW2-6 — FSK CD Delay (Bell 202 Mode Only)

SW2-6	ON = 23ms OFF = 6ms
-------	------------------------

SW2-6 selects the FSK CD delay and is valid when Bell 202 mode is active (SW2-1 OFF). Setting SW2-6 ON configures the modem to turn on CD 23 milliseconds after it detects a valid carrier signal. Setting this switch to OFF configures the modem to turn on CD 6 milliseconds after it detects a valid carrier signal.

This switch setting is deactivated when the modem is configured for V.23 mode (SW2-1 ON) and a delay of 18 milliseconds is used instead.

SW2-7 — Remote Loopback

SW2-7	ON = Loopback enabled OFF = Loopback disabled
-------	--

During instances of channel noise, the modem may mistake a received preamble as a request to go into remote digital loopback. Setting SW2-7 to OFF prevents the modem from participating in a remote digital loopback with another modem. SW2-7 does not prevent the modem from sending a remote digital loopback request to a remote modem.

SW2-8 — Reserved (Test Only)

SW2-8	Must be OFF
-------	-------------

SW2-8 must be in the OFF position for normal operation.

SW3 DIP Switch Settings

SW3 is a 10-position DIP switch. Table 2-5 shows the modem switch settings for DIP switch SW3. A description of the SW3 switch settings follows the table.

Table 2-5. Modem Switch Settings for DIP Switch SW3

Switches	Switch Settings	
	ON	OFF (Default)
SW3-1: Fast Poll/FSK (page 15)	FSK	Fast Poll Auto-Rate
SW3-2: Data Rate (page 15)	4800 bps	9600 bps
SW3-3: Async Character (page 16)	11 bits	10 bits
SW3-4: Auto RTS (page 15)	Enabled	Disabled
SW3-5: Transmitter Termination (page 16)	Switched by RTS	600 Ω
SW3-6: Reserved (Test Only) (page 16)	Test	Normal
SW3-7: 2- or 4-wire (page 17)	2-wire, half-duplex	4-wire, full-duplex
SW3-8: Carrier Control (page 17)	Constant	Switched
SW3-9: Rx Termination (page 17)	600 Ω	High Rx Impedance
SW3-10: Signal Ground and Earth Ground Option (page 17)	Connected	Separated

SW3-1 – Fast Poll Auto Rate/FSK

SW3-1	ON = Low-Speed Mode (FSK) OFF = High-Speed Mode (Fast Poll)
-------	--

The modem has two operating modes:

- ❖ FSK mode, which supports data rates from 0 to 1800 bps.
- ❖ Fast-poll mode, which supports data rates of 4800 and 9600 bps.

SW3-1, along with the Data Rate Selector (DRS) pin on the modem's RS-232 connector, configures the modem for either FSK or fast-poll mode. Table 2-6 shows how SW3-1 and the DRS signal configure the modem for these operating modes.

Table 2-6. Modem Operating Mode

To Select...	Set SW3-1 to...	And the DRS Signal...
Fast-poll mode	OFF	Is not connected or is set HIGH
FSK mode	OFF	Is set LOW
FSK mode	ON	Doesn't care

You should use the DRS signal in RTS control mode. It does not work in either constant carrier mode (SW3-8 set to ON) or in the auto-RTS mode (SW3-4 set to ON). The DRS signal is only sampled when the transmitter is idle (when not sending a preamble, data, or a turn-off sequence).

Note that the DRS control both the transmitter and receiver. If DRS changes states while the modem is receiving a preamble, data, or a turn-off sequence, the state of the receiver is unknown until the carrier drops and a new preamble is received. We recommend that the DRS does not change states until both the local and remote modems' transmitters are in the idle state. When they are, both the local and remote modems' DRS signal should change states.

SW3-2 – Data Rate (Fast-Poll Mode Only)

SW3-2	ON = 4800 bps OFF = 9600 bps
-------	---------------------------------

SW3-2 configures the modem speed. When the modem is in high-speed fast-poll mode (SW3-1 OFF), setting SW3-2 ON selects 4800 bps, while setting SW3-2 OFF selects 9600 bps.

SW3-3 – Async Character (Fast-Poll Mode Only)

SW3-3	ON = 11 bits OFF = 10 bits
-------	-------------------------------

Switch SW3-3 selects whether the async character is 10 or 11 bits long. When the modem is in high-speed fast-poll mode (SW3-1 OFF), setting SW3-3 ON selects an 11-bit async character, while setting SW3-3 OFF selects a 10-bit async character.

SW3-4 – Auto RTS (Fast-Poll Mode Only)

SW3-4	ON = Enable Auto RTS OFF = Disable Auto RTS
-------	--

For data terminals that do not support hardware RTS, set SW3-4 to ON to enable auto RTS mode. In this mode, TXD is detected at the modem and an internal RTS signal is turned ON. After training completes, the TXD is transmitted to the remote modem. The transmitter turns off if no TXD is detected after 1 character length of idle time. Auto RTS is used in fast-poll mode only (SW3-1 set to OFF).

SW3-5 – Transmitter Termination

SW3-5	ON = Switched by RTS OFF = 600 Ω
-------	--

SW3-5 is used for multi-point configuration networks. When multiple modems are connected on the same metallic circuit:

- ❖ The transmitter termination should be of high impedance if the modem is not transmitting.
- ❖ The transmitter is only terminated with 600 ohms when RTS is asserted.

This configuration should be used for all slave modems to prevent the transmitting modem from being unnecessarily burdened. To select this configuration, set SW3-5 ON on the slave modems.

If you use the modem with transmission lines that are transformer-coupled or with an impedance-isolated network (such as a transformer bridge), set SW3-5 to OFF for proper operation.

SW3-6 – Reserved (Test Only)

SW3-6	Must be OFF
-------	-------------

SW3-6 must be in the OFF position for normal operation.

SW3-7 – 2-/4-Wire Operation

SW3-7	ON = 2-Wire, Half-Duplex Mode OFF = 4-Wire, Full-Duplex Mode
-------	---

SW3-7 configures the modem for 4-wire full-duplex or 2-wire half-duplex operation.

SW3-8 – Carrier Control

SW3-8	ON = Constant OFF = Switched
-------	---------------------------------

SW3-8 selects either constant or switched carrier. Constant carrier allows DTEs, such as asynchronous dumb terminals or RTUs, to operate with modems, without the input RTS signal. When constant carrier mode is enabled (SW3-8 set to ON), the modem forces the transmit carrier active and the RTS-CTS delay is minimum (<0.5 ms.).

You can use constant carrier in 4-wire, point-to-point or multi-point applications (from master to slave modems).

In switched-carrier mode (SW3-8 set to OFF), the RTS/CTS delay is active.

SW3-9 – RX Termination

SW3-9	ON = Enable Rx Termination OFF = Disable Rx Termination
-------	--

SW3-9 selects whether RX termination is enabled for a modem. If you set this switch ON, the receiver is terminated with 600 Ω . If you set this switch OFF, the receiver is not terminated.

SW3-10 – Grounding Option

SW3-10	ON = Signal Ground and Earth Ground are Connected OFF = Signal Ground and Earth Ground are Separated
--------	---

Installing the Modem

After you set the modem's configuration switches, you can now install it in a slot within an RM16M Rack or an RMX shelf from Raymar-Telenetics.

The modem is installed or replaced from the front of the modem cage or modem rack, without disturbing the cable connections on the back. The modem can be installed and removed without having to remove power from the modem cage or modem rack. Special tools or test equipment are not required for installing the modem.

1. Wear an antistatic wrist strap over your wrist on your bare skin (not over a shirt or jacket).
2. Remove the wrapping that is protecting the modem.
3. Open the front panel door of the RM16M modem rack and pick an empty slot.
4. Hold the modem so the front panel LEDs are facing you and the edge connectors are pointing to the backplane of the modem rack.
5. Install the modem into the selected slot in the modem rack (see Figure 2-3).
6. Push firmly on the modem to seat it properly into the slot and backplane. The back of the modem rack contains the connectors for interfacing to the Data Terminal Equipment and communications line. Figure 2-4 shows how the modems look when installed in the rack.
7. Replace the front panel of the modem cage or modem rack.



Figure 2-3. Installing the Modem

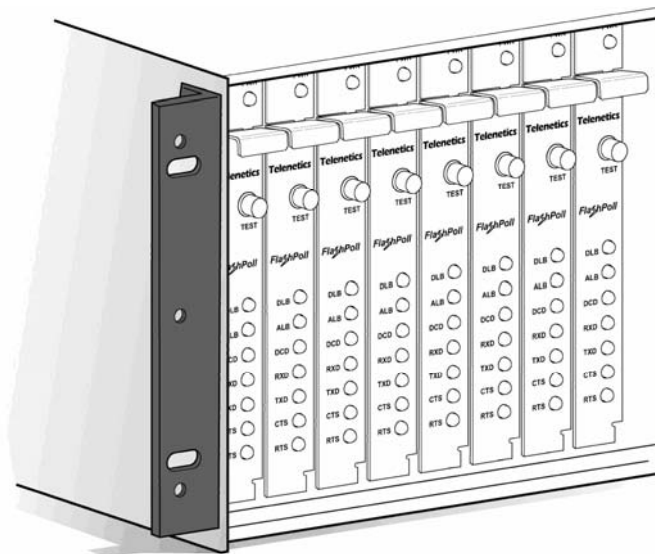

Figure 2-4. Modems Installed in the Rack

Connecting to a Transmission Line

The modem rack has different Telco options. Your version may have 16 8-pin modular jack connectors, one for each slot in the modem rack. It may also have an optional 50-pin mass-termination Telco connector.

To connect your modem to a leased line using the modular jack connectors, refer to “Modular Jack Connectors” below. To use the 50-pin mass-termination connector, refer to “Mass Termination Connector” on page 20.

Modular Jack Connectors

The rear panel of the modem rack has an 8-pin RJ-45 jack for each slot. After you install the modem into a slot, connect the slot’s corresponding RJ-45 jack to a leased line.

Leased lines have four contacts: a transmit (Tx) pair and a receive (Rx) pair. For communication to occur:

- ❖ The Rx line of the modem cage or modem rack RJ-45 jack must connect to the Tx line of the other modem.
- ❖ The Tx line of the modem cage or modem rack RJ-45 jack must connect to the Rx line of the other modem.

For more information, refer to the documentation that came with your modem cage or modem rack.

Mass Termination Connector

As an option, a 50-pin mass-termination connector can be used as the Telco connection for the modem(s). For more information, refer to the documentation that came with your modem cage or modem rack.

Connecting an RS-232 Device

The modem cage or modem rack has different RS-232 options for accepting an attached RS-232 (RTU) device. Your version may have a female, 25-pin RS-232 connector for each slot in the modem cage or modem rack. It may also have an optional 50-pin mass-termination Telco connector. For more information, refer to the documentation that came with your modem cage or modem rack.

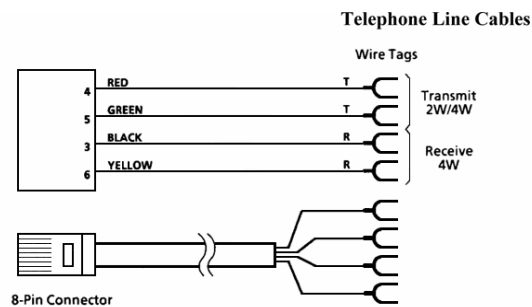

Figure D-3. Leased Line Cable

LEDs

The front panel of the modem provides the LEDs shown in Table 2-7.

Table 2-7. Modem LEDs

LED	Color	Description
Power	Green	Power
RTS	Yellow	Request To Send
CTS	Yellow	Clear To Send
TxD	Yellow	Transmit Data
RxD	Yellow	Receive Data
DCD	Yellow	Carrier Detect
ALB	Red*	Analog Loopback
DLB	Red*	Digital Loopback
* When the modem is in remote loopback, both the ALB and DLB LEDs go ON.		

Loopback Control Switch

The front panel of the modem has a push button for initiating the following loopback diagnostic tests:

- ❖ Local analog loopback — started by pressing the button one time.
- ❖ Local digital loopback — started by pressing the button two times.
- ❖ Remote digital loopback — set the local modem's RTS signal to low. Then press the modem's diagnostics button three times and raise the local modem's RTS signal to start the test. The **ALB** and **DLB** LEDs go ON on the remote modem when the modem is in Remote Digital Loopback. This test is available in Fast Poll mode only. Switch 2, position 7 must be ON on the remote modem to enable remote digital loopback.

Figure 2-6 illustrates these three diagnostics.

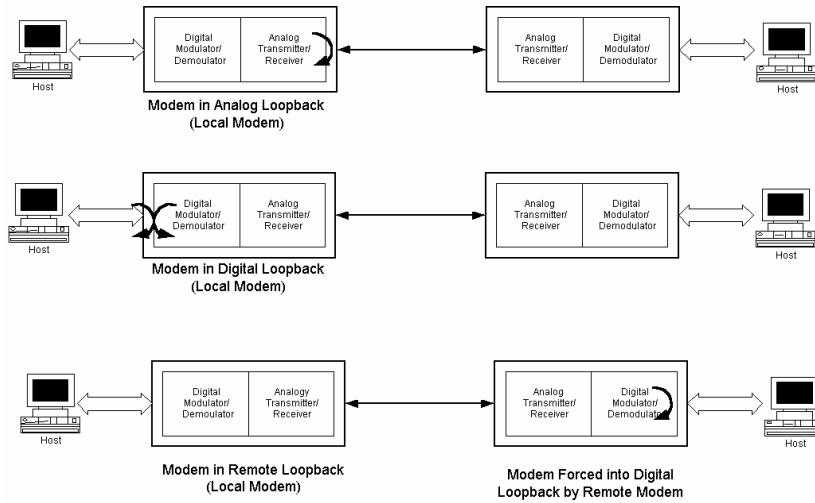

Figure 2-6. Loopback Diagnostics

Appendix A

Troubleshooting

In the event you encounter a problem using your modem, refer to the troubleshooting information in this appendix. To troubleshoot the power supply and backplane on the modem rack, refer to the documentation that came with your modem rack.



IMPORTANT

If you encounter a problem with your modem, be sure the modem switches are set to the appropriate positions. If a switch is halfway between an on and off setting, the modem will not operate properly.

Problem Solving

Table A-1 offers troubleshooting solutions for modem problems.

Table A-1. Troubleshooting Suggestions

If...	Perform These Procedures...
Modem does not respond and all LEDs are off.	Check the modem rack power supply module(s).
Modem does not receive data, and the DCD and RxD LEDs are off.	The receive line pair may be disconnected from the modem. Make sure the transmission line connection to the rear panel of the modem rack is accurate and secure. The receive signal level may be below the CD threshold. Set SW1-5 ON to see whether configuring the modem for a -43 dBm threshold resolves the problem.
The RTS , CTS , and TxD LEDs do not blink.	The attached terminal or DTE may not be sending data to the modem. Verify that data is being transmitted. If data is being transmitted, make sure the RS-232 cable is sound and securely connected to the modem and terminal or DTE.

Appendix B

Specifications

General Specifications

Data rate:	9600, 4800, or 0-1800 bps asynchronous
Data format:	8 or 9 data bits with 1 or more stop bits
DTE interface:	EIA RS-232 or V.24 compatible
Line conditions:	TELCO Voice band 4- or 2-wire leased line, conditioned or unconditioned Private metallic circuits up to 9.5 miles (24 AWG) without cable equalizer. Up to 15.0 miles (24 AWG) with TX and RX cable equalizer
Operating modes:	2-wire half-duplex or 4-wire full-duplex
Modulation:	High-speed fast poll – Raymar-Telenetics proprietary FSK, Bell 202T compatible <ul style="list-style-type: none">• Mark = 1200 Hz• Space = 2200 Hz• Soft Carrier = 900 Hz
Equalizer:	Automatic, adaptive
RTS-CTS Delay:	23 ms. (fast poll) 8, 33, 59, or 219 ms (FSK)
Receiver dynamic range:	0 to -30 dBm or -10 to -43 dBm
Operating temperature:	-40°C to +85°C
Surge protection:	Leased line, up to 15KV
Carrier Control:	Constant or switched, DIP switch selectable
Carrier loss recovery:	Train on Data

Throughput delay: Less than 10 milliseconds for fast polling.

Auto RTS: Support DTE without hardware RTS
(high speed only)

Anti-Streaming: 27-second timer to prevent transmitter lock-up network

Mechanical Specifications

Dimensions: 9 inches deep x 6.25 inches high x .87 inches thick

Weight: 8 ounces (card only)

Back-to-Back Connections to a Second Modem

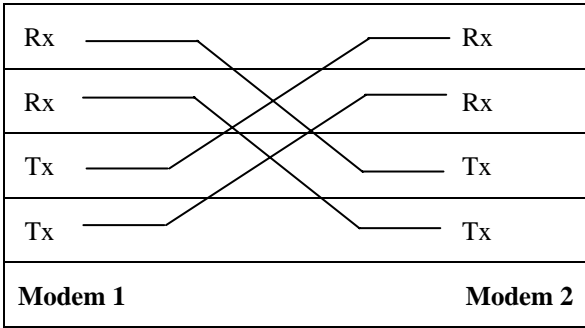

See page 24, Figure D-3.

RS-232 (RTU) Interface

Signal Name	Modem Input/Output	DB25 Pin	Description
Earth GND	—	1	Earth Ground
TXD	Input	2	Transmit Data
RXD	Output	3	Receive Data
RTS	Input	4	Request To Send
CTS	Output	5	Clear To Send
DSR	Output	6	Data Set Ready (Modem Ready)
SG	-	7	Signal Ground
DCD	Output	8	Data Carrier Detected
DTR	Input	20	Data Terminal Ready (Host Ready)

Environmental Specifications

Operating temperature:	-40 to + 85° C
Storage temperature:	-40 to +125° C
Operating humidity:	5 to 95 %, non-condensing
Isolation:	3750 V RMS
Surge protection:	Leased line up to 15K VA

Appendix C

Limited Product Warranty

One Year Limited Hardware Warranty

Raymar Information Technology, Inc., dba Raymar-Telenetics, warrants their products against defects in hardware, material and workmanship under normal use for one (1) year from the date of purchase. Raymar will, at no charge, either repair the product (with new or reconditioned parts), or replace it (with a new or reconditioned product). Repaired replacement products are warranted for either 90 days or the remainder of the original warranty period, whichever is longer. This warranty extends to the original end-user only.

What This Warranty Does Not Cover

This warranty does not cover: (a) software; (b) installation or service of the product; (c) conditions resulting from consumer damage such as improper maintenance or misuse, abuse, accident or alteration; (d) all plastic surfaces (including display screens) and all other exposed parts that are scratched or damaged due to normal use; (e) operation of our products with equipment not supplied by Raymar (f) products which have had the serial number removed or made illegible; or (g) products rented to others. This warranty applies only to hardware products manufactured by or for Raymar Information Technology, Inc. and identified by the Raymar-Telenetics trademark, trade name or product identification logo affixed to them. Refer to the Service and Support section of the User's Guide for service after the warranty expires. No warranty is made as to coverage availability or grade of service provided by the carrier.

General Provisions

This warranty sets forth Raymar's entire hardware responsibilities regarding this product. Repair, replacement or refund of the purchase price is at Raymar's discretion. THIS WARRANTY IS GIVEN IN LIEU OF ALL OTHER EXPRESS WARRANTIES, IMPLIED WARRANTIES, INCLUDING WITHOUT LIMITATION IMPLIED WARRANTIES OF MERCHANTABILITY AND FITNESS FOR A PARTICULAR PURPOSE, AND ARE LIMITED TO THE DURATION OF THIS LIMITED WARRANTY. IN NO EVENT SHALL RAYMAR BE LIABLE FOR DAMAGES IN EXCESS OF THE PURCHASE PRICE OF THE PRODUCT, FOR ANY LOSS OF USE, LOSS OF TIME, INCONVENIENCE, COMMERCIAL LOSS, LOST PROFITS OR SAVINGS, OR OTHER INCIDENTAL, SPECIAL OR CONSEQUENTIAL DAMAGES ARISING OUT OF THE USE OR INABILITY TO USE THIS RAYMAR PRODUCT, TO THE FULL EXTENT SUCH MAY BE DISCLAIMED BY LAW. WITHOUT LIMITING THE FOREGOING, RAYMAR SHALL HAVE NO LIABILITY FOR ANY DATA STORED IN OR USED WITH THE PRODUCT, INCLUDING THE RECOVERY COSTS OF SUCH DATA OR PROGRAMS.

State Law Rights

SOME STATES DO NOT ALLOW THE EXCLUSION OR LIMITATION OF INCIDENTAL OR CONSEQUENTIAL DAMAGES OR LIMITATIONS ON HOW LONG AN IMPLIED WARRANTY LASTS. THE ABOVE LIMITATIONS OR EXCLUSIONS MAY NOT APPLY TO YOU. This warranty gives you specific legal rights, and you may also have other rights which vary from State to State.

Provincial Law Rights

SOME PROVINCIAL LAWS DO NOT ALLOW THE EXCLUSION OR LIMITATION OF IMPLIED WARRANTIES, THE EXCLUSION OR LIMITATION OF WARRANTY COVERAGE IN CERTAIN SITUATIONS. SOME OF THE ABOVE LIMITATIONS OR EXCLUSIONS CONTAINED IN THIS LIMITED WARRANTY MAY NOT APPLY TO YOU. This warranty gives you specific rights, and you may have other rights which vary from province to province.

How To Use Raymar's Limited Warranty Service

To take advantage of this warranty, you must do the following:

- If you are having trouble with your product, contact Raymar service using the appropriate number from the Service and Support section of the User's Guide. If it is determined that your product requires service, you will be issued a Return Materials Authorization (RMA) form.
- Pack the defective product securely for shipping. Include only the units pre-approved by service on your RMA form.
- This warranty is void if the product is damaged in transit, you must insure your shipment.
- Ship the defective product, proof of date of purchase, and the RMA form to the address specified.
- Display your RMA number prominently on the outside of the shipping box. Customer is responsible for freight in, door to door. Raymar is responsible for return shipping costs.
- To ensure prompt service, please write on the RMA form a brief description of the problem you are experiencing with the product.

Raymar Information Technology, Inc.

7325 Roseville Road

Sacramento, CA 95842

Service Hotline (800) 747-1522

<http://support.telenetics.com> or e-mail to techsupport@raymarinc.com

Appendix D

RMA Procedure

Return Merchandise Authorization (RMA) Procedure

Before returning any Raymar-Telenetics product, an RMA number must be obtained.

The most convenient way to obtain an RMA number for a product purchased from Raymar-Telenetics is to call **1-800-747-1522**. When doing so, please have the following information ready:

- Company name
- Full billing address, as well as the address for the location where the product should be returned once repaired or replaced
- Telephone & Fax numbers
- Email address
- Product model number and serial number

For each item being returned, please include the product model number, the serial number, a description of the problem being encountered, and the cause of the problem (if known).

Please note that prior to authorizing a return, a product support specialist may call to verify that the product is properly installed or may ask you to perform tests to insure that the product has actually failed.

The product must be properly packed and returned to:

Raymar-Telenetics
7325 Roseville Road
Sacramento, CA 95842

The RMA number must be legibly displayed on the shipping carton. Raymar-Telenetics will not be responsible for any product returned without an RMA number.

If the product is out of warranty, estimates for repair rates and any applicable shipping costs will be communicated by a customer service representative. Currently, Raymar-Telenetics accepts purchase orders or credit cards as payment methods.

Repairs currently require 5 – 10 business days and are returned via UPS Ground.